

Comfort & Convenience

- Smooth Belt driven motorised curtain track system
- Touch Impluse Technology, gently pulling the curtain by hand will activate the motor
- Integrated Emergency Control - In case of a power failure, the drapes can be moved manually
- Can be operated by Wall Switch, Remote Control or Time Switch
- Easy to connect to Building Automation System
- Clickable off-set carrier for a straight heading of the curtain (allowing track to be covered when curtains are closed)
- Top Fix or Face Fix application available
- Vanda Wave Heading available
- Ultra Silent Motor
- 10 Year Warranty

Bending/curving

- The motor can drive a curtain with one or two bends of 90 degrees in the track
- The track can be bent and reversed bent with a radius of 20 cm (150mm). Curved / Rolled
- Tracks can be joined to extend a maximum of 10 L/M

- Forest Diamond remote Control
- 6 channel remote control, possibility to control up to 6 systems individually and in group Radio control, range up to 30 meters



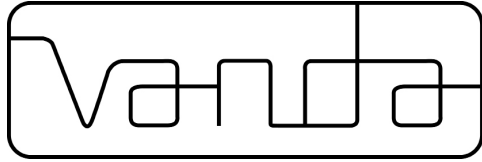

FOREST FMS TRACK PROFILE

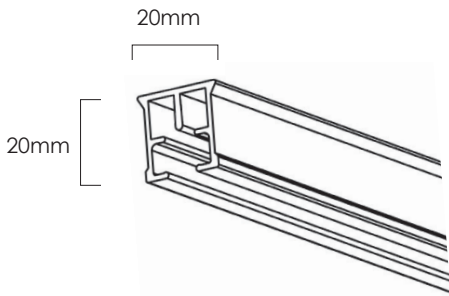

FMS TRACK - GLIDE/CARRIER

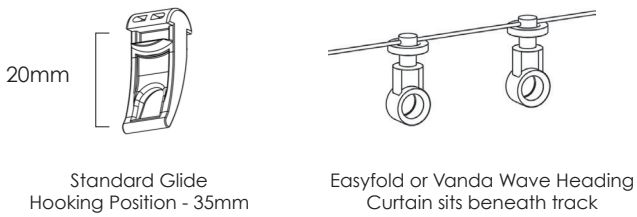

FOREST SHUTTLE MOTOR DIMENSIONS

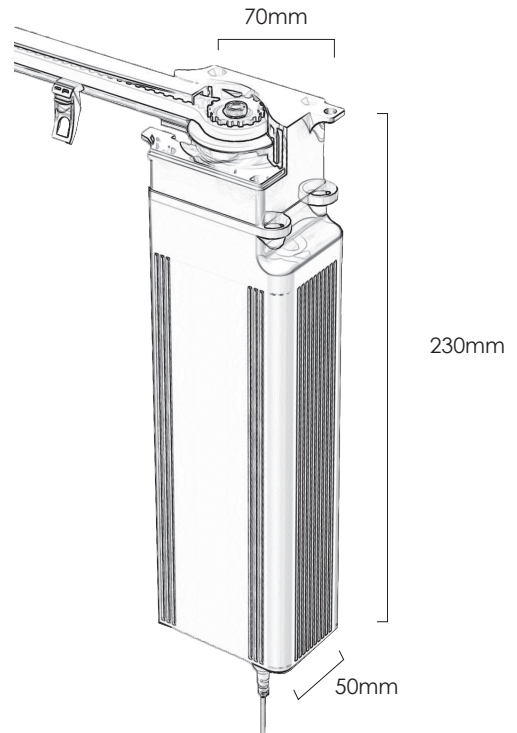

FOREST TOP FIX BRACKET

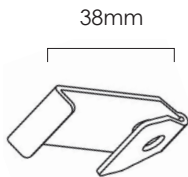

Single Adjustable Bracket
Adjustable from
75mm to 115mm

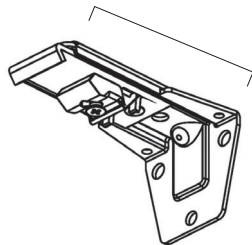

42mm

FOREST FACE FIX BRACKET

Double Adjustable Bracket
Adjustable from
Front Track - 65mm to 100mm
Back Track - 54mm to 110mm

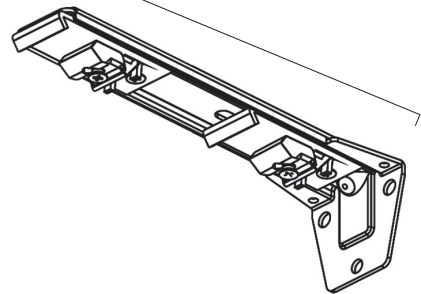

44mm